

Precision Machined Bearings

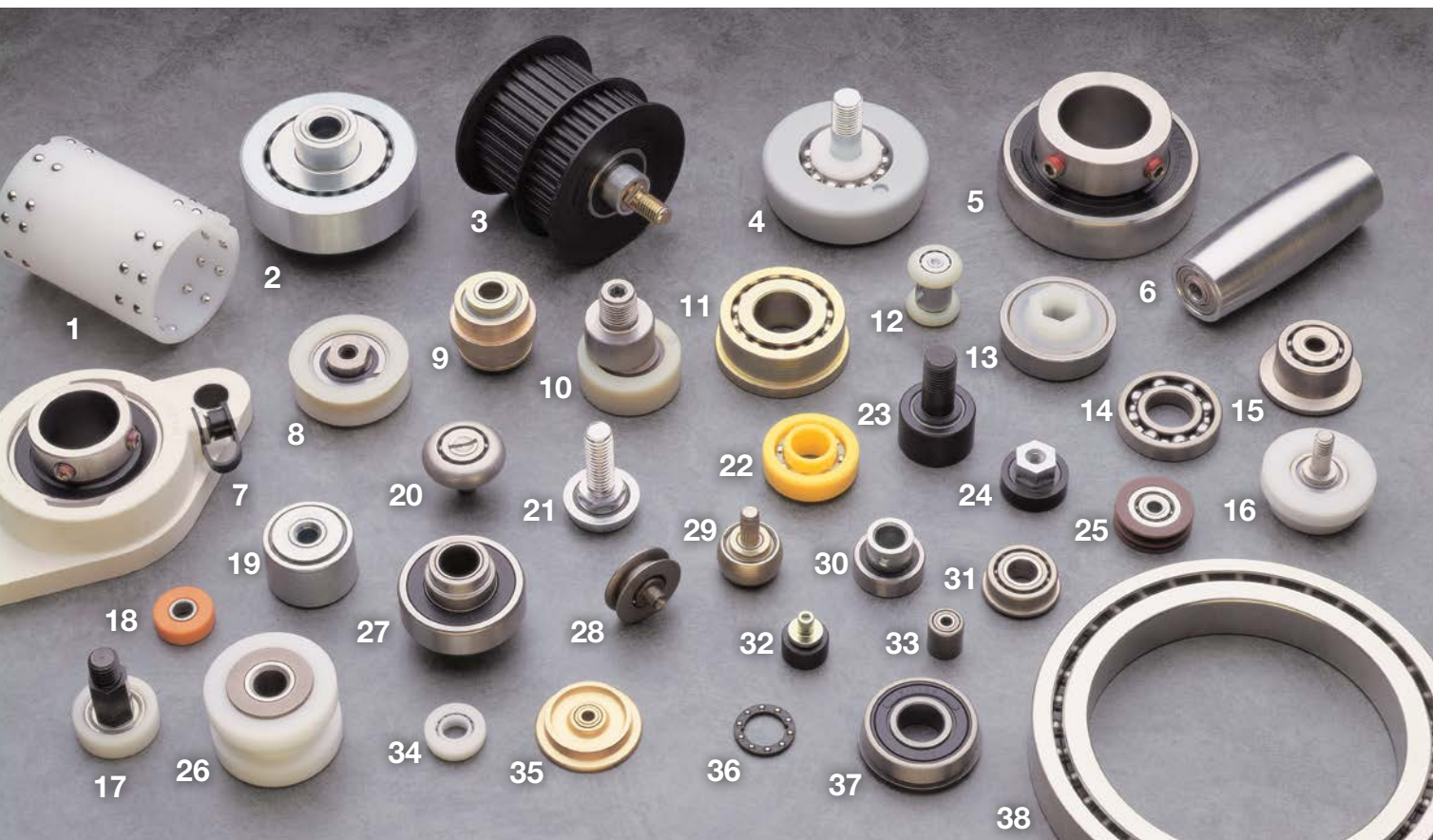



A Selection of Customized Products by Kilian

1. Plastic cage and ball assembly
2. Corrosion resistant bakery conveyor bearing
3. Business machine timing belt assembly
4. Corrosion resistant poultry trolley assembly
5. Stainless steel wide inner ring bearing
6. Aluminum aircraft roller assembly
7. Corrosion resistant housed unit
8. Plastic pulley for sports equipment
9. Plated and sealed bearing for agricultural machinery
10. Eccentric stud with hex drive
11. Corrosion resistant bearing for outdoor winch
12. Double row assembly for room partitions
13. CB-14 bearing for conveyors
14. Stainless steel caged ball bearing for pumps
15. Bearing with nickel plated flange for food preparation
16. Bearing with nylon molded to outer ring for idler
17. Precision cam follower in molded tire
18. Delrin outer ring bearing for infant device
19. Double row conveyor bearing for food industry
20. All stainless bearing for food trays
21. Flanged and sealed assembly for furniture
22. All plastic bearing for quiet baby device
23. Cam follower for blood processing machine
24. Bearing with plastic tire for packaging machine
25. Plastic pulley bearing for ventilation hood doors
26. Stainless steel and plastic trolley assembly
27. Precision assembly
28. Hinge bearing for oven doors
29. Cam follower for automotive door hinge
30. Precision bearing with setscrews for business machine
31. Flanged stainless steel bearing for toaster
32. Automotive van door bearing
33. Double row cam follower for sewing equipment
34. Plastic angular contact bearing for appliances
35. Wheel assembly for toy locomotive
36. Thrust cage and ball assembly for power tool
37. Sealed wheel bearing for lawn care equipment
38. All stainless bearing for bottling plant



Kilian, the world's largest producer of precision machined bearings, is a leader in providing custom bearing solutions, superior engineering and responsive technical services for major automotive and industrial customers.

Kilian bearings set the standard for cost-effective performance — as part of our basic offering or through special designs developed to solve specific customer problems. Our unique ability to combine bearings with other components into integrated unit assemblies provides greater value for our customers.

The benefits of Kilian bearing technology are available across a wide size range of 1/8-in. bore to 6-in. O.D. and a variety of materials, including carbon steel, stainless steel and engineered polymers. Our broad capabilities provide unmatched flexibility to supply customer requirements in high or low volume, including custom designs for specialized applications.

For more than 80 years, we have earned an unequalled reputation for value engineering and customer satisfaction. Advanced manufacturing and quality systems assure our continued success in meeting today's most demanding requirements.

Our sales, engineering and customer service teams provide rapid, world-class support for any customer inquiry. Talk to one of our engineers who will provide fast technical recommendations and solutions. and Kilian's talented field sales team adds value by providing on-site customer support.



Prototypes are made quickly to customer requirements.

Engineering

Our experienced engineers help you optimize your design. Their familiarity with your product and industry will save you time and money. A Kilian-engineered design includes a careful review of load, speed, size, lubrication and environment. Our engineers work together with manufacturing and quality team members to make sure we meet all your requirements.

“We do whatever it takes to satisfy our customers!”

Prototypes

At Kilian, we pride ourselves on our ability to develop new products quickly and cost effectively for customers. Our engineers create new designs on CAD within days and prototypes follow within weeks. These samples are made on production equipment that represents the actual manufacturing process. Durability testing confirms analytical performance predictions.



A vision system quickly verifies print conformance.

Customer Service

Kilian's customer service is unmatched. Familiar with your account and trained to answer your questions, your customer service representative is located right in the manufacturing plant. Your field sales engineer serves as a local technical resource, working closely with the Kilian engineering staff. More than 2,500 local distributor branches stock Kilian standard catalog items and provide assistance as required.

Quality Commitment



Automation ensures quality of critical assembly operations.

Manufacturing Reliability

Automotive, aircraft and medical products around the world rely on Kilian precision machined bearings. Our engineering process, which includes design for manufacturability, assures cost efficiency and product reliability. Our skilled technicians operate best-in-class machinery. Widespread automation and electronic sensors help maintain the integrity of critical assembly operations.

Quality Assurance

At Kilian we strive to reduce variation in every product and process, while continually enhancing our ISO 9001:2015 / IATF 16949:2016 registered quality systems. Beginning at the design stage, our quality process is defined by a formal Control Plan. This contains well-documented procedures that are communicated, performed and verified. Our operators, who are responsible for the quality of the work they produce, use Statistical Process Control (SPC) to ensure that their processes remain “in control.”

Electronic gauges and SPC help reduce variation.

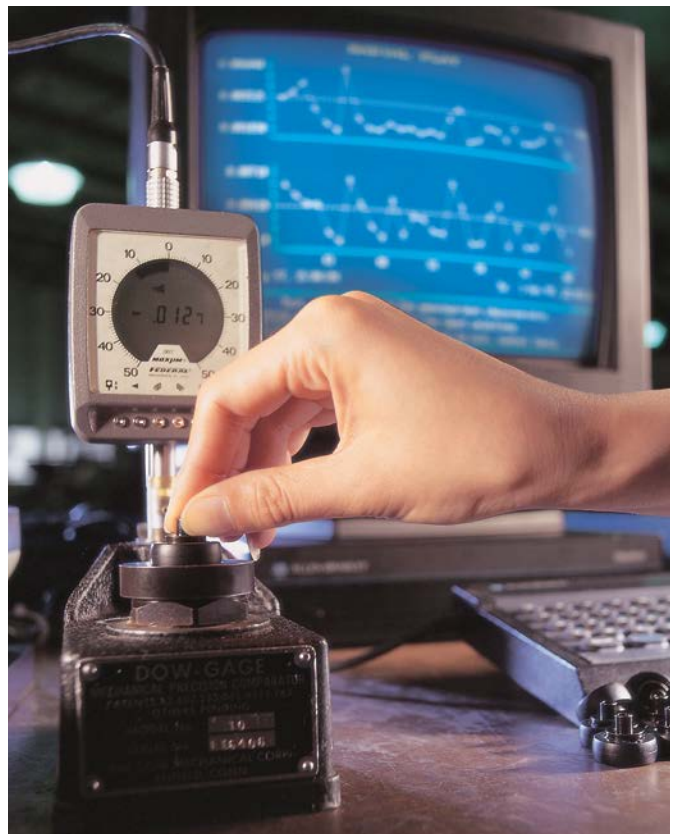

Kilian specializes in custom bearing solutions. Our equipment and processes are engineered for maximum flexibility with quick change-over. This enables us to produce a design which is unique for you, in quantities as small as 5,000 pieces. The bearings and assemblies in this brochure reflect only a sampling of our capabilities. Kilian is often able to reduce significantly the total cost of our customers' products by incorporating the shaft, housing or gear into the bearing design. Kilian can supply complete subassemblies, functionally tested and ready for installation. Our solutions can save you considerable time and expense, while enhancing your product quality and reliability.

The Problem

- Many separate components to buy
- Inventory control complexity
- High assembly cost
- Tolerance stack-up problems



The original design contained eight parts.



Our Solution

Kilian reduces the number of components to one integral unit through value engineering. This cuts your costs and improves the reliability of your product. The Kilian assembly is easier to order, schedule and install. Let Kilian supply your pulley, gear, housing or shaft, too.

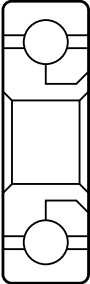
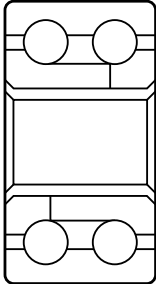
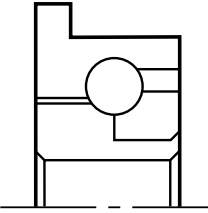
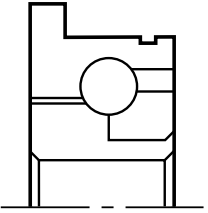
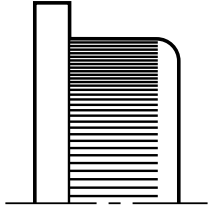
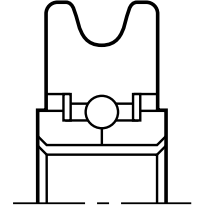

The Kilian solution is a single assembly.

Design Your Own Bearing

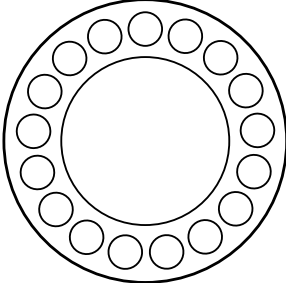
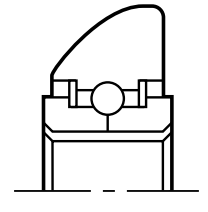
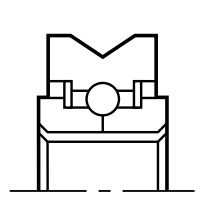
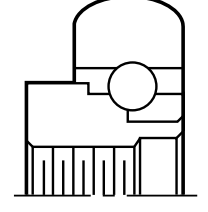
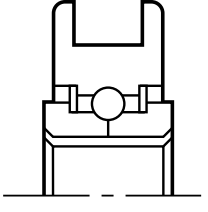
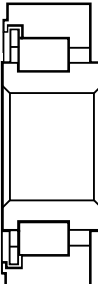
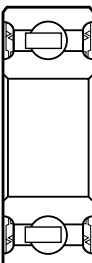
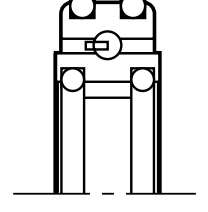
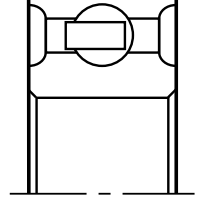
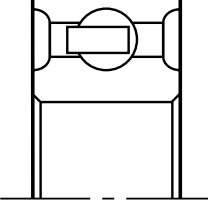
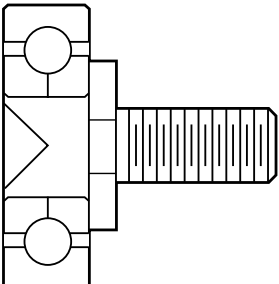
BASIC BEARING TYPES		SELECT AN OUTER RING PROFILE	
			
Single Row Radial Ball	Double Row Radial Ball		
			
Angular Contact	Ball Thrust		
			
Roller	Retainer		
			
Cam Follower			

CUSTOMIZE AN ATTACHMENT FEATURE

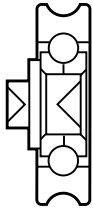

Rivet

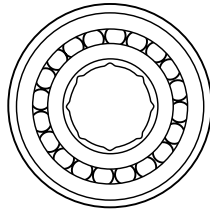

Hex Bore

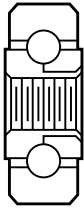

Threaded Bore

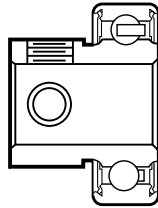

Setscrew

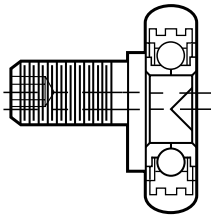

Eccentric Stud

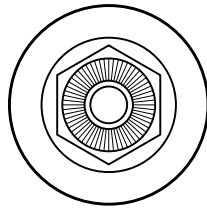

Face Knurl

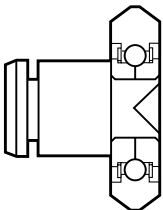

Snap Ring

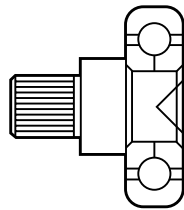

Knurled Stud

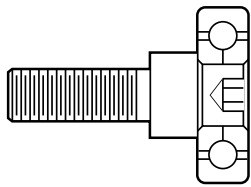

Threaded Stud Hex Drive

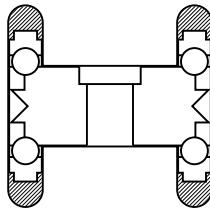

Cross Hole

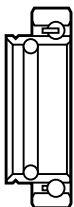

O-Ring for Press Fit

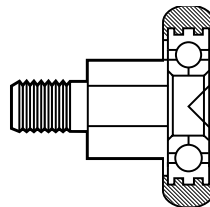

Hex Drive

ADD A SEAL

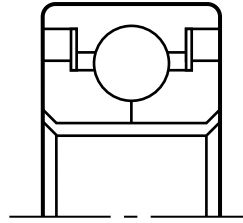

Teflon Face Seal

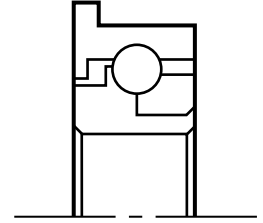

Labyrinth

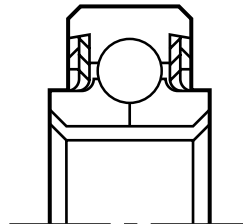

2-Piece: Teflon Lip & Retaining Ring

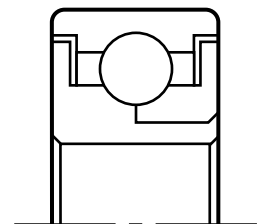

Double Shield

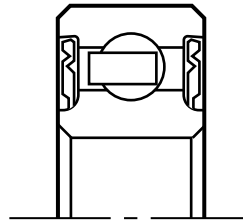

Molded Lip Contact Seal

SPECIFY AN ALTERNATE MATERIAL

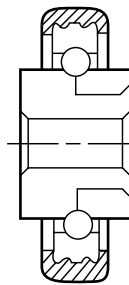

Polymer on Steel Ring

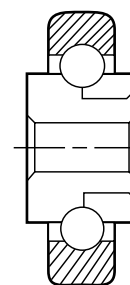

Polymer Outer Ring

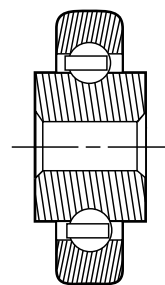

Polymer Inner and Outer Rings

ALSO AVAILABLE:

- Anti-corrosive platings
- Stainless steels
- Various engineered polymers

Optional Bearing Components



A broad assortment of seal styles and materials is available.



Stainless steels, various platings and polymers are available.

Seals

Seals can be added to keep contamination out of our bearings, or to help keep grease in. Various labyrinth designs offer cost-effective options. Teflon seals are a choice for low-torque performance. Lip contact seals can be molded from rubber or thermoplastic for maximum effectiveness.

Material Options

The majority of our bearings are manufactured from carbon steel. Various heat treat processes produce the hardness and case depths required by specific applications. Special platings and coatings provide the required corrosion resistance or appearance. We use stainless steels when severely corrosive environments are anticipated. Also, engineered polymers can reduce rolling noise or corrosion. We can form a tire by insert-molding polymers to the steel bearing, or make the entire bearing of an engineered polymer.



Ball retainers allow higher speeds.

Cage-Type Bearings

Nylon finger-style cages are available in many sizes. The caged design provides better ball guidance, allowing higher speed capabilities (up to 2000 rpm). By separating the balls, the cage also provides a quieter bearing. This design can hold more grease for longer life in difficult applications.

Full-Complement Ball Bearings

The Kilian full-complement design allows the assembly of the maximum number of balls without a loading slot. This construction provides the greatest load capacity while minimizing cost. It is suitable for applications where noise and speed are not critical.



Roller bearings support higher loads.

Roller Bearings

Using rollers instead of balls provides additional load capacity and stability. A full complement of cylindrical rollers can be used for most applications.

CAUTION: Before using any Kilian bearing in a critical application that could affect personal safety or property, please consult our Engineering Department to determine product and performance capabilities.

Precision Machined Standard Bearings

CB14 Conveyor Bearings

Design and Operational Specifications:

- Meet the speed and reliability requirements of driven conveyor rolls
- Significantly reduce noise level of the conveyor system
- Precision machined from quality steel
- Feature flanged O.D. for ease of mounting
- Both rings are of one-piece construction
- Nylon ball retainer permits operation up to 2000 RPM
- Unique nylon adapter in bore to accommodate standard 7/16 in. hex shafting and dampen noise normally transmitted to the conveyor frame

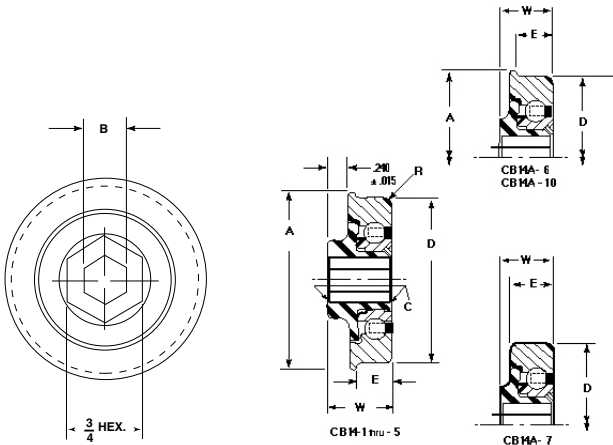

Bearing Number	Hex Bore	Outside Diameter D	Flange A ±.015	Width W		C	R
	B			W	E		
	in.	in.	in.	in.	in.	in.	in.
CB14-1	.466/.456	1.469/1.464	1.537	.712	.372	.040/.020	3/16
CB14-2	.466/.456	1.503/1.498	1.574	.712	.410	.040/.020	5/64
CB14-3	.466/.456	1.529/1.524	1.600	.712	.410	.040/.020	5/64
CB14-4	.466/.456	1.880/1.875	1.951	.712	.410	.040/.020	5/64
CB14-5	.466/.456	1.603/1.598	1.675	.712	.410	.040/.020	5/64
CB14A-6	.466/.456	1.712/1.707	1.783	.520	.410	.040/.020	5/64
CB14A-7	.466/.456	1.712/1.707	—	.520	.472	.040/.020	5/64
CB14A-10	.466/.456	1.628/1.623	1.700	.520	.410	.040/.020	5/64

Single Row Ball Bearings

Design and Operational Specifications:

- Designed for light loads and speeds up to 1200 RPM
- Full complement of precision steel balls in deep ball grooves
- Heat-treated races machined from steel bar stock to a controlled finish
- Thrust capacity in either direction is 50% of listed radial rating

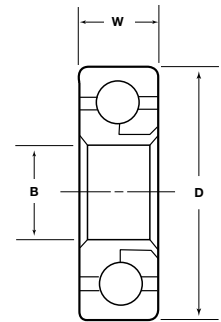

Bearing Number	Bore B	Outside Diameter D	Width W	Balls	Radial Load Rating at 600 RPM	
	Tolerance +.005 to -.000	Tolerance +.000 to -.005	Tolerance ±.005	No. Size	lbs	
	in.	in.	in.	in.	lbs	
SR253	3/16	11/16	1/4	11	1/8	29
SR254	1/4	11/16	1/4	12	1/8	32
SR255	1/4	3/4	1/4	13	1/8	34
SR255-89	3/16	3/4	1/4	10	5/32	41
SR266	3/16	7/8	1/4	12	5/32	49
SR267	1/4	7/8	1/4	12	5/32	49
SR268	5/16	7/8	1/4	15	1/8	40
SR269	3/8	7/8	1/4	16	1/8	42
SR270	5/16	29/32	5/16	13	5/32	53
SR280-1	5/16	15/16	5/16	13	5/32	53
SR281	3/8	15/16	5/16	17	1/8	45
SR290	1/4	1	5/16	13	5/32	53
SR290-90	3/8	1	5/16	14	5/32	53
SR311	1/4	1-1/16	1/4	13	5/32	53
SR312	5/16	1-1/16	1/4	13	5/32	53
SR314	5/16	1-1/16	3/8	13	5/32	53
SR315	3/8	1-1/16	3/8	14	5/32	57
SR333	3/8	1-1/8	3/8	14	5/32	57
SR337	1/2	1-1/8	3/8	16	5/32	66
SR340-1	3/8	1-3/16	3/8	13	3/16	81
SR342	3/8	1-1/4	3/8	13	3/16	81
SR342-58	1/2	1-1/4	3/8	15	3/16	87
SR347	1/2	1-9/32	5/16	15	3/16	87
SR381	1/2	1-3/8	7/16	17	3/16	99
SR500	1/2	1-1/2	7/16	13	1/4	136
SR503	5/8	1-1/2	7/16	13	1/4	136
SR550	1/2	1-9/16	7/16	14	1/4	147
SR620	3/4	1-5/8	3/8	15	1/4	157

⚠ WARNING: Cancer and Reproductive Harm
www.P65Warnings.ca.gov

Precision Machined Standard Bearings

Flange-Type Ball Bearings

Design and Operational Specifications:

- Designed for light loads and speeds up to 1200 RPM
- Mount directly into wheel hubs, pulleys and conveyor rollers
- Full complement of precision steel balls in deep ball grooves
- Heat-treated races machined from steel bar stock to a controlled finish
- Thrust capacity in either direction is 50% of listed radial rating

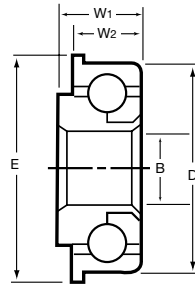

Double Row Ball Bearings

Design and Operational Specifications:

- Designed for light loads and speeds up to 1200 RPM
- Double row of full complement precision steel balls in deep ball grooves for increased stability
- Heat-treated races machined from steel bar stock to a controlled finish
- Thrust capacity in either direction is 33% of listed radial rating

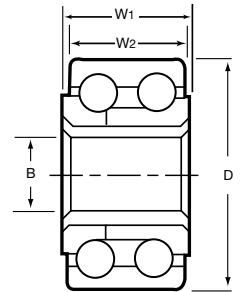

Bearing Number	Bore B	Outside Diameter D	Width W ₁	Width W ₂	E	Balls		Radial Load Rating at 600 RPM
	Tolerance +.005 to -.000	Tolerance +.005 to -.000	Tolerance ±.005			No.	Size	
	in.	in.	in.	in.	in.	in.	lbs	
F150	1/4	11/16	5/16	1/4	13/16	12	1/8	32
F155	1/4	3/4	5/16	1/4	7/8	12	1/8	32
F160	1/4	13/16	5/16	1/4	29/32	13	1/8	34
F165	5/16	7/8	5/16	1/4	1	15	1/8	40
F175-1	1/4	29/32	7/16	3/8	1	13	5/32	53
F175-2	5/16	29/32	7/16	3/8	1	13	5/32	53
F175-3	3/8	29/32	7/16	3/8	1	16	1/8	42
F175-4	7/16	29/32	7/16	3/8	1	17	1/8	45
F200-1	7/16	29/32	7/16	11/32	1-1/16	17	1/8	45
F225	3/8	1	7/16	3/8	1-1/8	14	5/32	57
F250	7/16	1-1/16	7/16	3/8	1-3/16	15	5/32	61
F250-2	3/8	1-1/16	7/16	3/8	1-3/16	15	5/32	61
F300	1/2	1-1/8	1/2	3/8	1-1/4	16	5/32	65
F300-19	3/8	1-1/8	1/2	3/8	1-1/4	16	5/32	65
F310	1/2	1-3/16	1/2	3/8	1-5/16	16	5/32	65
F325	9/16	1-1/4	1/2	7/16	1-3/8	18	5/32	74
F350-11	3/8	1-3/8	1/2	7/16	1-1/2	11	1/4	115
F350-12	1/2	1-3/8	1/2	7/16	1-1/2	12	1/4	125
F350-13	5/8	1-3/8	1/2	7/16	1-1/2	17	3/16	99
F350-89	3/4	1-3/8	7/16	3/8	1-1/2	22	5/32	90
F500	11/16	1-1/2	5/8	7/16	1-5/8	18	3/16	110
F550	1/2	1-9/16	21/32	17/32	1-11/16	12	1/4	125
F600-3	3/4	1-5/8	9/16	1/2	1-3/4	15	1/4	157
F700	3/4	1-11/16	9/16	1/2	1-13/16	15	1/4	157
F750	3/4	1-3/4	5/8	9/16	1-7/8	15	1/4	157
F750-21	1/2	1-3/4	5/8	9/16	1-7/8	15	1/4	157
F850	5/8	1-7/8	5/8	9/16	2	17	1/4	178
F1000	7/8	2	5/8	9/16	2-1/8	19	1/4	200
F1000-4	1	2	5/8	9/16	2-1/8	19	1/4	200
F1100	11/4	2-1/8	5/8	9/16	2-1/4	21	1/4	220

Bearing Number	Bore B	Outside Diameter D	Width W ₁	Width W ₂	Balls	Radial Rating at 600 RPM	
	Tolerance +.005 to -.000	Tolerance +.000 to .005	Tolerance ±.005			No.	Size
	in.	in.	in.	in.	in.	lbs	
D2253	3/16	11/16	7/16	13/32	22	1/8	43
D2254	1/4	11/16	7/16	13/32	24	1/8	48
D2255	1/4	3/4	7/16	13/32	24	1/8	48
D2267	1/4	7/8	7/16	13/32	24	5/32	73
D2269	3/8	7/8	7/16	13/32	32	1/8	63
D2290	3/8	1	7/16	13/32	28	5/32	85
D2337	1/2	1-1/8	9/16	17/32	32	5/32	99
D2383	5/8	1-3/8	5/8	19/32	34	3/16	148
D2500	1/2	1-1/2	3/4	23/32	26	1/4	204
D3010	3/4	2	7/8	27/32	38	1/4	300

Load Rating Factors for Single, Double, and Flange-Type Standard Ball Bearings

Radial load ratings given for standard size bearings are based on a speed of 600 Rpm. For radial load ratings at speeds other than 600 RPM, multiply the listed rating by the appropriate factor indicated in the table to the right.

Table of Speed/Radial Load Rating Factors

Speed (RPM)	Factor
50	3.6
100	2.7
300	1.4
900	.8
1000	.7
1200	.6

⚠ WARNING: Cancer and Reproductive Harm
www.P65Warnings.ca.gov

Kilian Facilities

North America

USA

1728 Burnet Avenue
Syracuse, NY 13206 - USA
315-432-0700

*Engineered Bearing
Assemblies*



**Scan to see all
the brands of
Regal Rexnord**

Neither the accuracy nor completeness of the information contained in this publication is guaranteed by the company and may be subject to change in its sole discretion. The operating and performance characteristics of these products may vary depending on the application, installation, operating conditions and environmental factors. The company's terms and conditions of sale can be viewed at <https://www.kilianbearings.com/about-us/terms-and-conditions>. These terms and conditions apply to any person who may buy, acquire or use a product referred to herein, including any person who buys from a licensed distributor of these branded products.

©2023 by Kilian LLC. All rights reserved. All trademarks in this publication are the sole and exclusive property of Kilian LLC or one of its affiliated companies.