

I N T R O D U C I N G

ERD/ERDD GEN2 Brakes

Spring-Operated Brake / Electromagnetic Release
For Indoor / Outdoor Heavy Duty Applications

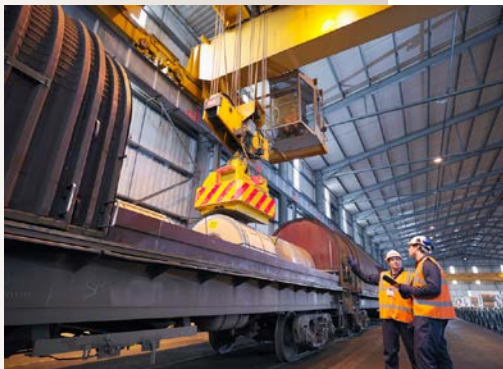
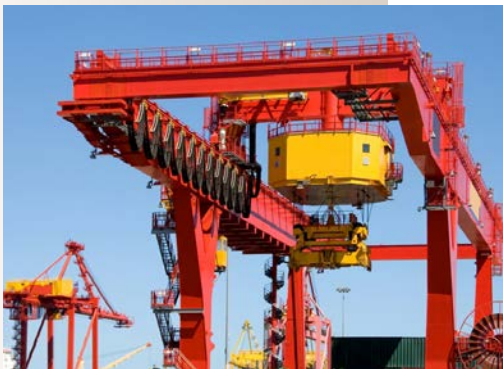
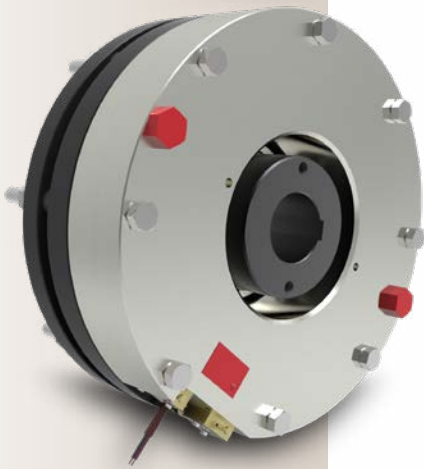

Features:

- High speed
- Low response time
- Activated by spring pressure
- Electrically released
- Single disc (**ERD**) or dual disc (**ERDD**)
- Horizontal or Vertical mount (**ERD**) preferred for Horizontal mount (**ERDD**)
- For dry use
- Duty cycle: 100% energized
- Wear compensation possible
- Ambient temperature: -40°C to + 50°C

Options:

- Release detection
- Wear detection
- Hand release
- Mounting flange
- Single or dual voltage coil
- Corrosion protection for outdoor/harbour applications
- DC power supply

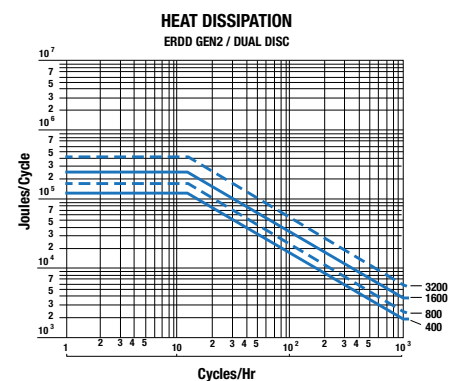
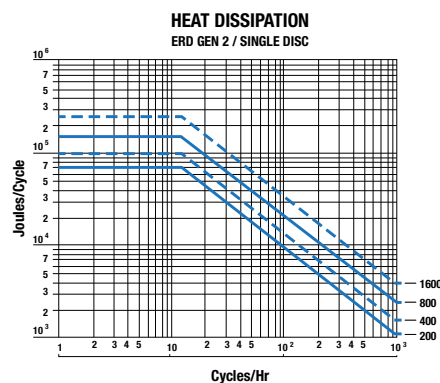

ERD (Single Disc) / ERDD (Dual Disc) GEN2 Spring-Operated / Electromagnetic Released Brake

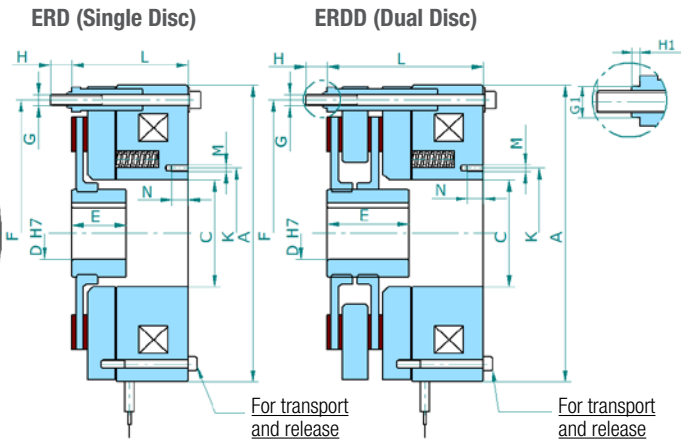
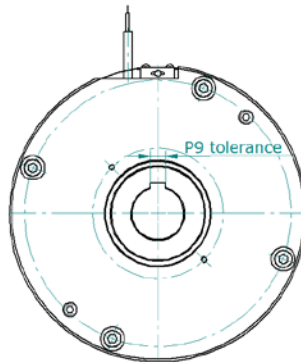
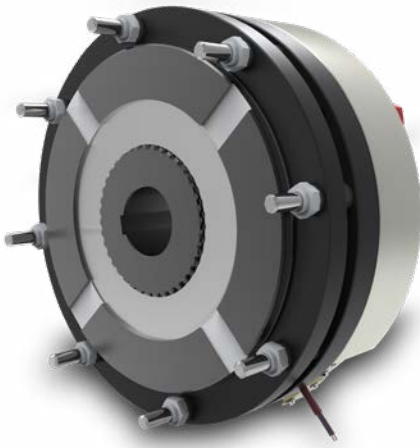

	Single Disc		Horizontal or Vertical Axis		Dual Disc preferred for Horizontal Axis			
Size	200	400	800	1600	400	800	1600	3200
Nominal Torque (Nm)	200	400	800	1600	400	800	1600	3200
Max Speed (rpm)	4700	4700	4700	3800	4700	4700	4700	3800

Single Voltage

Voltage (VDC)	103.5	103.5	103.5	103.5	103.5	103.5	103.5	103.5
Power (Watt)	76	155	207	327	76	155	207	327

Dual Voltage

Voltage (VDC)	207/103.5	207/103.5	207/103.5	207/103.5	207/103.5	207/103.5	207/103.5	207/103.5
Voltage (VDC)	360/180	360/180	360/180	360/180	360/180	360/180	360/180	360/180
Power (Watt)	187/47	482/120	625/156	607/151	187/47	482/120	625/156	607/151

A (mm)	215	273	332	395	215	273	332	395
C (mm)	77	98	145	190	77	98	145	190
D Pre-Bored (mm)	20	29	34	50	20	29	34	50
D max (mm)	45	65	80	110	45	65	80	110
E (mm)	35	60	70	100	35	60	100	100
F (mm)	196	245	305	369	196	245	305	369
G (mm)	6 x M8	6 x M10	8 x M12	8 x M12	6 x M8	6 x M10	8 x M12	8 x M12
G1 (mm)	9.5	14.5	16	16	9.5	14.5	16	16
H min	18	22	26	25	21	25	31	28
H1 min	3	4	4	4	3	4	4	4
K (mm)	93	120	165	210	93	120	165	210
L (mm)	91	107	103	134	118	144	138	171
M (mm)	2 x M6	2 x M6	2 x M8	2 x M8	2 x M6	2 x M6	2 x M8	2 x M8
N (mm)	12	12	12	15	12	12	12	15
Inertia (Kg•m2)	0.003	0.009	0.024	0.086	0.005	0.015	0.043	0.126
Weight (Kg)	12	31	45	115	15.3	47	69	130

Standard Keyways according to DIN6885-1 / tolerance P9
Service manual: SM446